

## PRODUCT MODEL NUMBERS

WRF57R18D      WSR57R18D  
WRR56X18F

### Recommended grounding method

A 115 Volt, 60 Hz., AC only, 15- or 20-amp fused, grounded electrical supply is required. It is recommended that a separate circuit serving only your freezer be provided. Use an outlet that cannot be turned off by a switch. Do not use an extension cord.

**NOTE:** Before performing any type of installation, cleaning, or removing a light bulb, turn the control (Thermostat, Refrigerator or Freezer Control depending on the model) to OFF and then disconnect the refrigerator from the electrical source. When you are finished, reconnect the refrigerator to the electrical source and reset the control (Thermostat, Refrigerator or Freezer Control depending on the model) to the desired setting. See "Using the Controls."

## PRODUCT DIMENSIONS

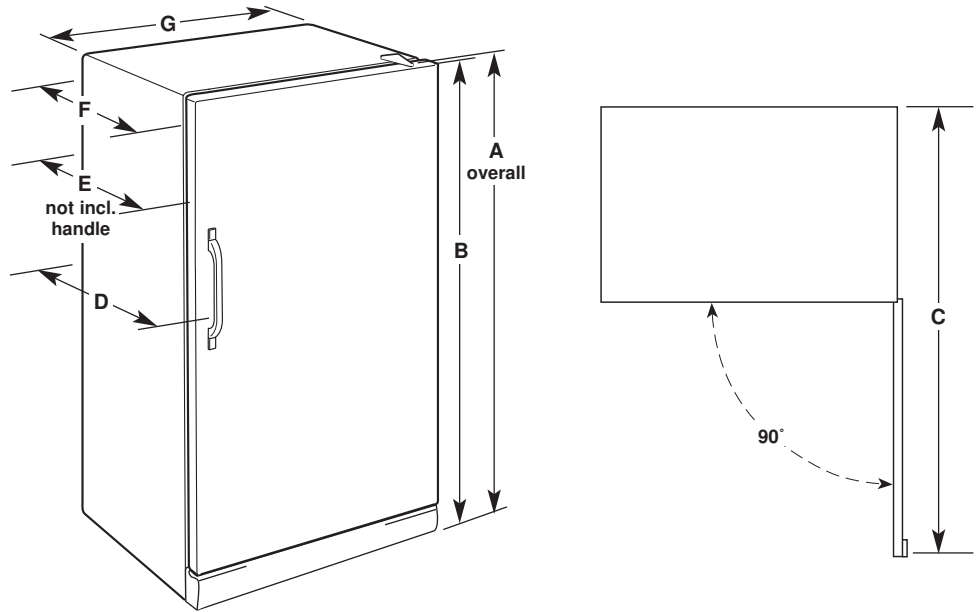

Model Number	Model Size	Door Swing	Height - Overall "A"	Height - Top of Cabinet "B"	Depth - Door Open 90° "C"	Depth - With Handles "D"	Depth - Without Handles "E"	Depth - Cabinet Only "F"	Width - Cabinet "G"
WRF57R18D WRR56X18F	17.7 cu. ft.	Right	66 <sup>3</sup> / <sub>8</sub> " (169.5 cm)	66 <sup>1</sup> / <sub>2</sub> " (168.3 cm)	55 <sup>7</sup> / <sub>8</sub> " (141.9 cm)	30" (76.2 cm)	29 <sup>1</sup> / <sub>2</sub> " (74 cm)	24 <sup>5</sup> / <sub>8</sub> " (62.5 cm)	30 <sup>1</sup> / <sub>2</sub> " (76.8 cm)
WSR57R18D	17.7 cu. ft.	Right	66 <sup>3</sup> / <sub>8</sub> " (169.5 cm)	66 <sup>1</sup> / <sub>2</sub> " (168.3 cm)	55 <sup>3</sup> / <sub>8</sub> " (141.6 cm)	31 <sup>1</sup> / <sub>2</sub> " (79.4 cm)	28 <sup>7</sup> / <sub>8</sub> " (73.3 cm)	24 <sup>5</sup> / <sub>8</sub> " (62.5 cm)	30 <sup>1</sup> / <sub>2</sub> " (76.8 cm)

## LOCATION REQUIREMENTS

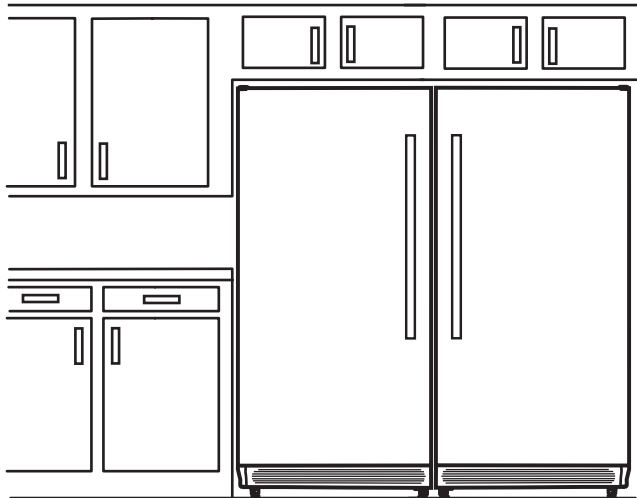

### Ventilation and Clearance

- This freezer may be installed side by side with another refrigerator or freezer. Allow at least 1" (2.54 cm) between back of cabinet and the wall, and a 1/4" (6.4 mm) clearance between the appliances.
- If you are installing your refrigerator next to a fixed wall, leave extra space on the hinge side so the door can open wider.
- Keep flammable materials and vapors, such as gasoline, away from freezer.
- Do not cover the freezer with items such as blankets, sheets, tablecloths, etc. This reduces air circulation.

### Temperature

Your freezer operates most efficiently when located in an area where the temperature will not fall below 40°F (5°C). Place your freezer in a location where the temperature will not fall below this recommended temperature.